

HARMONICS GENERATED BY HYDROELECTRIC POWER PLANTS AND WIND FARMS IN THE POWER SYSTEM



Auob Ashrafpour^{1,a,*}, Ghazanfar Shahgholian^{2,b}

¹*Department of Electrical Engineering, Najafabad Branch, Islamic Azad University, Najafabad, Iran*

**Corresponding Author:*

E-mail: auobashrafpour@yahoo.com

(Received 14th January 2020; accepted 06th April 2020)

a:  ORCID xxxx-xxxx-xxxx-xxxx, b:  ORCID 0000-0003-2774-4694

ABSTRACT. This paper presents a real power system which consists two types of power supplies. The power system consists a wind farm and a hydroelectric power system and other system components, such as loads, transformers, transmission lines and compensatory. First, a harmonic analysis is performed for a system in Greece. Then, a real system in Iran is simulated using the model of System's harmonic components and the produced harmonics are studied. Network parameters also belong to information of Iran's transmission and distribution lines. First, power generation sources individually enter the circuit, then the current and voltage harmonic distortion generated by the wind farm and hydro power plant is analyzed and compared to each other. A real network is analyzed her by two methods of frequency scan and fast Fourier transform (FFT). Different typologies are implemented and the results are analyzed by MATLAB/Simulink. Finally, voltage and current harmonic components are determined using FFT analysis and it is obtained that harmonic distortion generated by wind farms is significantly more than harmonic distortion of hydropower plants.

Keywords: *wind farms, hydropower plant, total harmonic distortion (THD), transformer, transmission lines*

INTRODUCTION

An ideal power network is a network in which electrical energy is transferred as sine voltage and current at a constant frequency to consumption centers by power plants at certain voltages [1, 2]. However, in practice, presence of facilities with non-linear characteristics and power electronic devices in different sections leads to harmonic distortion in fine shape of current and voltage in power network [3, 4]. This shows importance of understanding and studying harmonics in power network as a new branch in engineering [5, 6].

One problem of electricity quality in distribution and transmission systems is harmonics issue which has received lots of attention and many investigations are performed about it in literature [7, 8]. Harmonic distortion causes specific problems in power network, such as lack of proper performance of facilities and reduction of life time and efficiency of devices [9, 10]. Increasing production of electricity from renewable resources has been one of the most important purposes of countries, to maintain nonrenewable resources and because of environmental issues [11, 12]. These resources consist producing electricity through hydroelectric power stations and wind farms. Increase in distributed production resources, increase in nonlinear loads, and resources like wind farms, which use power electronic devices- have caused growth of voltage and current's harmonic distortion in network that produce $6k+1$ harmonics [13, 14]. Statistics

show that there was about 148 billion dollars of investment in wind power plants at 2007 which shows a 60 percent growth comparing to 2006. The type of harmonic distribution in wind turbines is different from harmonic distribution of other devices such as loads and home devices. Effect of harmonic distribution on power system is an important matter which always should be watched during harmonic studies on power system [15, 16].

One of generators that is applied in wind turbines is double-fed induction generator (DFIG) [17, 18]. Double-fed induction generators are one of suitable devices for systems, therefore, variable speed wind turbines that are connected to these generators become capable of controlling active and reactive power [19, 20]. Considering the power electronic convertors that are connected to these generators, they can cause harmonic production in the system. Whenever these harmonics interfere with resonances that exist in network, they increase domain of these harmonics. A phenomena named resonance occurs in power systems because of presence of inductance and capacitance elements. Conditions for occurrence of resonance phenomena in transmission network is less than distribution networks. Natural frequency of circuit is more limited in transmission network comparing to natural frequency of distribution network because of higher capacitance, as a result it occurs at harmonics lower than feed voltage. Resonance in system happens as a result of inductance and capacitance elements; where, network resonances should be identified in harmonic studies. Connection of wind turbines via underground cables can introduce another capacitance element to system because capacitance of underground cables has significant impacts on system resonance frequency [21, 22]. Most of AC generators produce entirely Sine current and voltage. Nonetheless, modern distributed production systems use power electronic convertors for connection which this increase harmonic in system by itself. Some of distributed production resources are solar power plants, fuel cells, wind farms, and small hydropower plants [23, 24]. For implementing intended harmonic analysis purposes a multi-bus system with three feeders is used in this paper. Fast Fourier transform (FFT) (identify harmonics) is used in simulation because of its capabilities in fast calculations [25, 26]. A hydroelectric power plant is simulated in first section. 23.8 GW of electricity produced in Iran is via hydro power plants which this number is 150 MW for wind farms and is an insignificant and notable amount [27]. As there was a considerable progress in recent years at distributed production field, especially about wind energy, lots of investigations are performed in control and performance as a result of disturbances of these devices in power network, too. Of disturbances in network, transient response and permanent state of turbines under voltage's unbalanced conditions are mostly concerned [28].

System's harmonic studies is an important issue for power network strength quality. Therefore, a power system with all components should go under harmonic investigation and all of power quality's standards about harmonics should be considered for them. In this paper, a real system in Greece goes under harmonic analysis; then, a real system is simulated using harmonic model of system components. This real power system is consisted of two power production resource, hydro power plant, and wind power plant. This system includes twenty wind turbine (MANJIL 1), with capacity of 680 KW each- and also a hydro power plant (KAROUN 4), which includes 4 power production unit with capacity of 1000 MW each. This set is connected to a network with 400 KV and 5000 MVA. This system also includes several hundreds of air lines and several loads. Results of system simulation and harmonics' impact on different components of system are indicated. Calculating total harmonic distortion (THD) and frequency scan (resonance identification) are applied for identification of resonances during FFT analysis. At the

end, harmonic elements of current and voltage are determined using fast Fourier transform (FFT) and it is indicated that harmonic distortion produced as a result of wind farms is significantly more than harmonic distortion in hydro power plants.

SIMULATION OF POWER SYSTEMS AND HARMONIC ANALYSIS

Purpose of simulation is to identify voltage's distortion and to find possibility of dangerous resonances and adjusting them with standards and consequently to apply modification and correction methods. Modeling steps include: identifying harmonic generative resources, properly modeling them, properly model other elements of system, and simulation for different forms.

Harmonic Model of System's Component

In this section, harmonic model of system's components, including asynchronous machine, transmission lines, types of loads, transformer, and synchronous machine, are shown.

Asynchronous and synchronous machine: Induction device with equivalent simplified circuit for showing harmonic frequency $f_r = h \cdot f_1$ is shown in Fig. 1 in where R_B and X_B are resistance and reactance of locked rotor, respectively. Also, $a = R_1/R_B$, where R_1 is stator's resistance and has a magnitude between 0.45-0.5. Sliding in frequency f can be calculated as:

$$s_h = \frac{\pm h \omega_1 - \omega_r}{\pm h \omega_1}$$

Eqn. 1

where ω_r is rotor's speed and \pm is for positive/negative sequence [29]. Harmonic model of synchronous machine is depicted in Fig. 2 where R_2 and X_2 are resistance and reactance of negative sequence, respectively. X_2 is usually estimated by under-transient reactance of d and q axels [30].

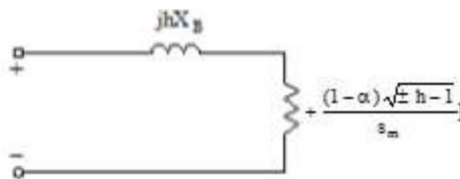

Fig. 1. Harmonic model for synchronous Machine

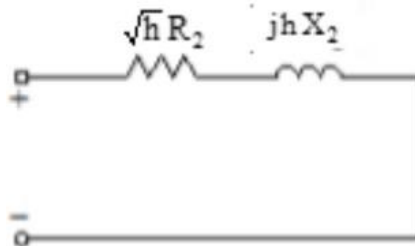

Fig. 2. Harmonic model for asynchronous Machine

$$X_2 = \frac{X_d'' + X_q''}{2}$$

Eqn. 2

(b) Transformer's harmonic model: In zero sequence, the side of star of null wire is earth, for transformer. In positive and negative sequence, transformer is modeled with series harmonic impedance equal to $Z_{k,h}=R_{kh}+jhX_k$; where, X_k is reactance of short circuit in fundamental frequency and R_{kh} is

$$R_{k,h} = R_k(c_o + c_1h^b + c_2h^2)$$

Eqn. 3

Also, R_k is resistance of short circuit in fundamental frequency. Values of (3) obtained as Table 1. Transformer's harmonic models is depicted in Fig. 3.

Table 1. Value of parameters for different transformer models

	c_o	c_1	c_2	B
Distribution Transformer	0.85-0.90	0.05-0.08	0.05-0.08	0.9-1.4
Transmission Transformer	0.75-0.80	0.10-0.13	0.10-0.13	0.9-1.4

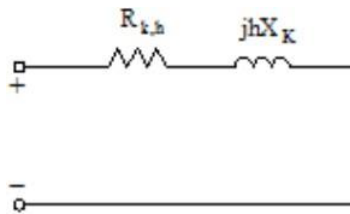

Fig. 3. Transformer's harmonic model

(c) Load's harmonic model: Different types of load include: passive, active (revolving or engine load), and power electronic (non-linear). Load's model is important for accurate evaluation of harmonic resonance domain. In this section, three harmonic models are shown for load which in all of them R_1 and X_1 are resistance and reactance of fundamental frequency, respectively. Harmonic model is depicted in Fig. 4 for three different loads.

(d) Choosing proper load model is important for evaluation of harmonic resonance domain. In this paper, model A is used for implementation of power systems, because this model has best performance comparing to others.

(e) Lines and cables' model: Pi model with compact parameters are used for air lines and cables. Resistance, inductor, and capacitor are distributed homogenously through distribution line for a transmission line. Distributed transmission line model should be used for air lines, if the length is more than 145 KM. Skin effect should be considered, because it weakens high frequency harmonics. An approximate model of line with distributed parameters obtained via locating several similar Pi sections as cascade. Despite spread parameter model, which have infinitive states, linear model of Pi sections

has a finite number of states which provide possibility for calculating linear state space model.

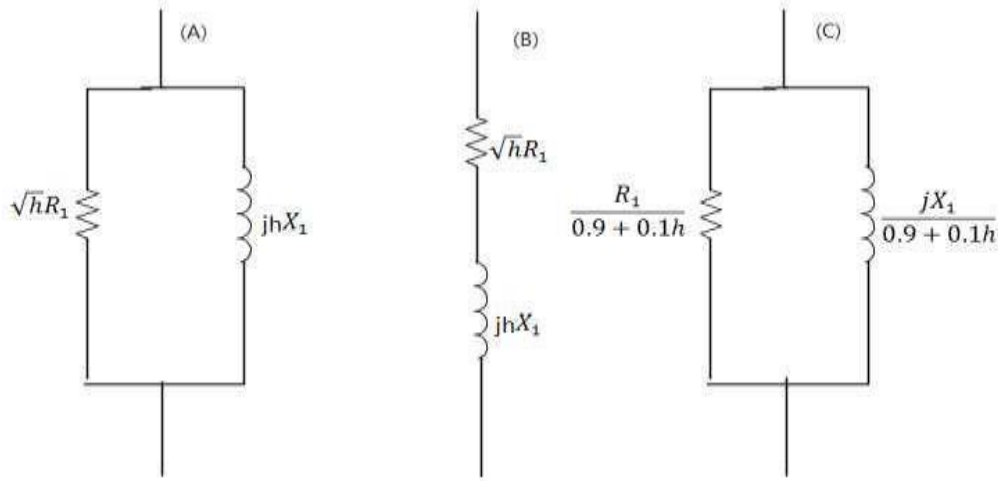

Fig. 4. Harmonic model for three loads

Current's Harmonics Measurement

Accurate harmonic implantation and analysis of a real system is a complicated problem that consists developed models for all of system's component -such as consumer's load. Harmonic components are time-variable. One reason is the change in point of turbine's work which consequently some changes occur in convertors through control system and pulse width modulation which leads to changes in harmonic components. Three-phase currents have components which are integer multiples of frequency in system as a result of harmonics. Three-phase harmonic current is obtained via following equations:

$$I_{R(h)} = \sqrt{2} I_n \cos(2\pi n f_o T + \theta_{(n)})$$

Eqn. 4

$$I_{S(h)} = \sqrt{2} I_n \cos(2\pi n f_o T + \theta_{(n)} - \frac{2n\pi}{3})$$

Eqn. 5

$$I_{T(h)} = \sqrt{2} I_n \cos(2\pi n f_o T + \theta_{(n)} + \frac{2n\pi}{3})$$

Eqn. 6

where, I_n is order n harmonic current, T is periodicity, and f_o is fundamental frequency. There is a property for current and voltage harmonic components. This property is THD. According to standard code IEC61000-3-6 current and voltage total harmonic distortion can be obtained by [31]:

$$THD = \frac{\sqrt{\sum_{h=2}^{h_{max}} M_h^2}}{M_1}$$

Eqn. 7

where M_h is the h^{th} effective harmonic component and M_1 is main component. THD is criteria for measurement of harmonic component's effective value of a distortion wave. Effective value of a wave is related to THD according to following equation. A wave's total effective value RMS isn't equal to summation of all its components, rather is obtained by summation of square of each components of that wave [32].

$$RMS = \sqrt{\sum_{h=1}^{h_{max}} M_h^2} = M_1 \sqrt{1 + (THD)^2}$$

Eqn. 8

Therefore, THD index is defined as ratio of harmonics to main component. If there is no main component, consequently the value of THD tends to infinity. Forasmuch as domain of higher order harmonics (orders more than 50) is insignificant, therefore analysis takes place until 50th harmonic and all values of harmonic voltage and current would be obtained in MATLAB software. The most accurate results will be obtained after 10 minutes of simulation. Harmonic active power also is calculated as

$$P_h = 3V_h I_h \cos(\phi_{v(h)} - \phi_{i(h)})$$

Eqn. 9

where, I_h and V_h are harmonic voltage and current, respectively. If value of $p(h)$ is greater than zero in equation (9), source of production of harmonic is in network's side; however, if $p(h)$ is less than zero, then source of production of harmonic is producer if power [33].

SIMULATION OF A POWER SYSTEM CONSISTING WIND FARMS IN GREECE

In this section, wind farm with capacity if 20`500 KW in a power network presented by Papathanassiou and Papadopoulos [34] is studied which includes several kilometers of high voltage and average voltage submarine and air lines with voltages of 150, 20, and 15. Then, system's harmonic impedance is analyzed and its value is calculated. Wind turbine which is connected to an average voltage network in Cephalonia city in Ionian Sea is studied. It is connected to a main power plant via continuous high and average voltage air lines and submarine lines. High capacity of underground cables -which can cause resonance condition- makes the analysis more difficult. Single-linear diagram of the studied system is depicted in Fig. 5. Triangle/star earthed transformers are used and error current is confined by a 10 Ohms resistance at second one. Harmonic spectrum is between 1-1.5 in old machines but it has decreased significantly in modern devices. When

there is minimum load, all compensators should switch to circuit. However, only one compensatory with a 12.5 MW should switch when there is maximum load. Argostoli's average voltage network -to which a wind turbine is connected- consists hundreds of kilometers of air lines. The turbine itself is not the component which creates harmonic, rather it is the converters that enter to network with the turbine; therefore, one can indicate the converters with a current resource by mentioning its phase. Output current wave is measured and harmonic spectrum is indicated in Fig. 6. Harmonic spectrum is between 1 and 1.5 KHz.

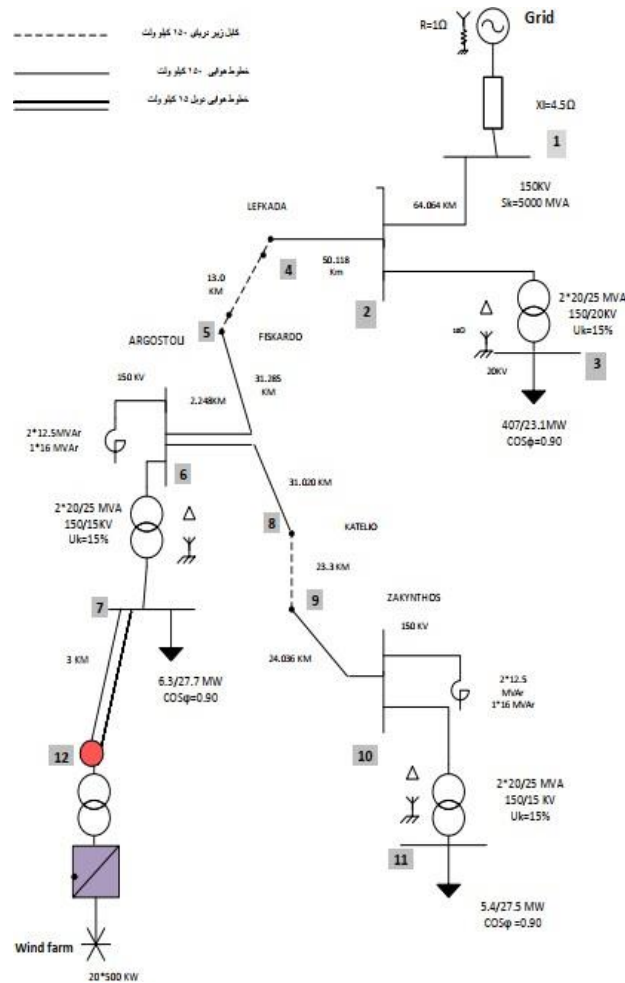

Fig. 5. Diagram of Greece single linear system (150 KV submarine Cable, 150 KV air lines and 15 KV double air lines)

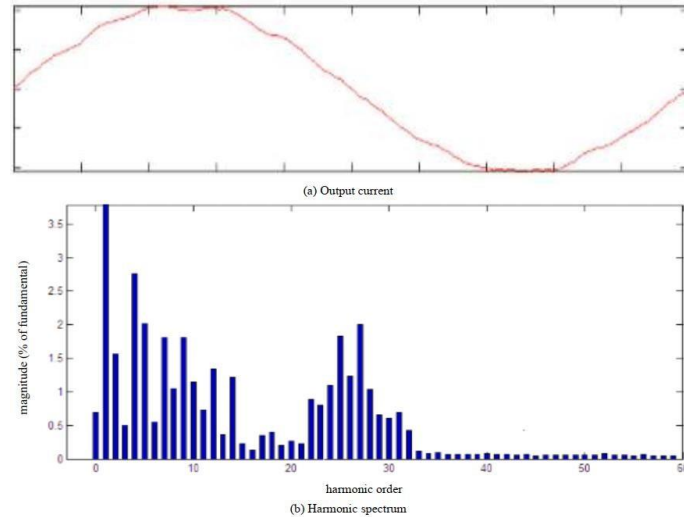

Fig. 6. Output current and harmonic spectrum measured in output of wind farm

Variable-speed wind turbines inject harmonic currents into the network of, which creates harmonic distortion problems. This paper explains modeling methods, then, performs calculations of load distribution. System harmonic Impedances are calculated according to harmonic models of components and main characteristics of system are discussed. Although variable-speed wind turbines are suitable machines for all components of system, but the harmonics produced by converters at the side of network may cause concerns in case of interference with network's resonance. Accurate harmonic implantation and analysis in a real system is a very complicated task which needs to be developed for all system components -including consumer's loads which is the most important concern in system. Implementation of load distribution studies is unreasonable for wind production sources in distribution networks because of their high number and relatively small size. Therefore, simple evaluation methods are approved for presenting fast results based in conservative hypothesizes.

Harmonic resources are modeled with current's source and expression of phase's angle in this impedance modeled. Coupling of various ordered harmonics with each other is neglected. A network equivalent with three-phase network, converted in symmetrical component area, is modeled. Therefore, zero sequence harmonic distribution is shown correctly and the only possible difference is in characteristics of positive and negative sequence of system.

Current's Frequency Spectrum

Average voltage network of Argostoli station, the place that wind turbines are connected, has several kilometers of 15 KV air lines (a capacity equivalent to 5 nF/Km) and 15 KV submarine cable lines (a capacity equivalent to 300 nf/Km) with the length of 6.5 Km. Total shunt capacity of this network evaluated to be about 6 mF. Output current curve and harmonic spectrum of wind turbine is shown at Fig. 6 and in high voltage bus at Fig. 7. Also components and total harmonic distortion in buses are presented in Table 2. Measurements are performed at the side with average voltage and currents can only include positive and negative sequence. Main harmonic spectrum is between 1 and 1.5

KHz. Considering harmonic spectrum at above figure one can observe that in harmonic spectrum can be problematic in older machines, but harmonic spectrum has decreased significantly for new machines in modern turbines.

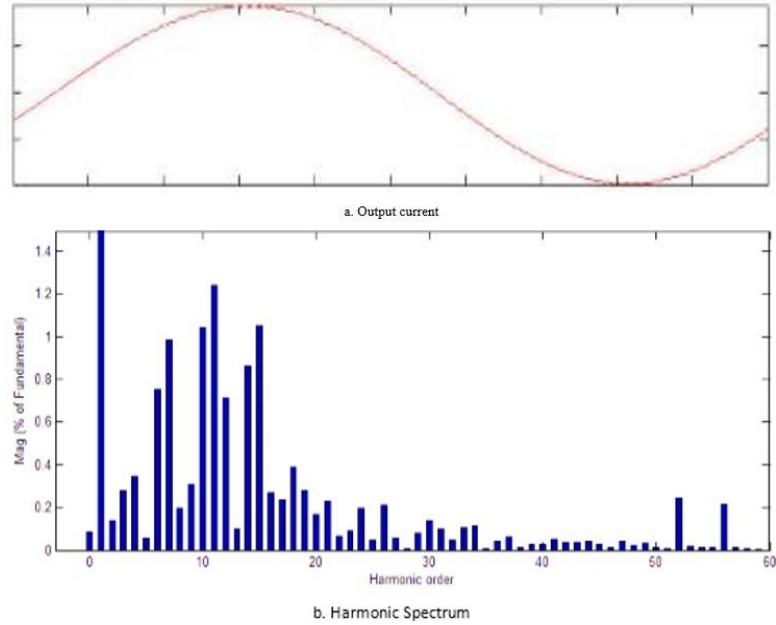

Fig. 7. Current and harmonic spectrum measured in high voltage bus

Table 2. Components and total harmonic distortions in all buses (% of frequency)

Bus Offer	PCC bus		High voltage bus	
	Current component	Voltage component	Current component	Voltage component
1	100	100	100	100
3	0.5	0.3	0.3	0.1
5	2	1.5	0.7	0.4
7	1.8	1.3	0.5	0.3
9	1.6	1.2	0.4	0.1
11	0.7	0.5	0.1	0.06
13	0.4	0.2	0.08	0.009
15	0.3	0.15	0.07	0.006
17	0.5	0.4	0.09	0.001
19	0.3	0.2	0.07	0.006
21	0.3	0.2	0.07	0.006
23	1.7	1.5	0.4	0.1
25	1.6	1.4	0.3	0.06
27	1.8	1.7	0.5	0.3
29	0.8	0.6	0.1	0.09
31	0.7	0.5	0.12	0.01
33 to 49	1.5	1.3	0.22	0.1
Total Harmonic Distortion	5.2%	2.78%	8.5%	0.39%

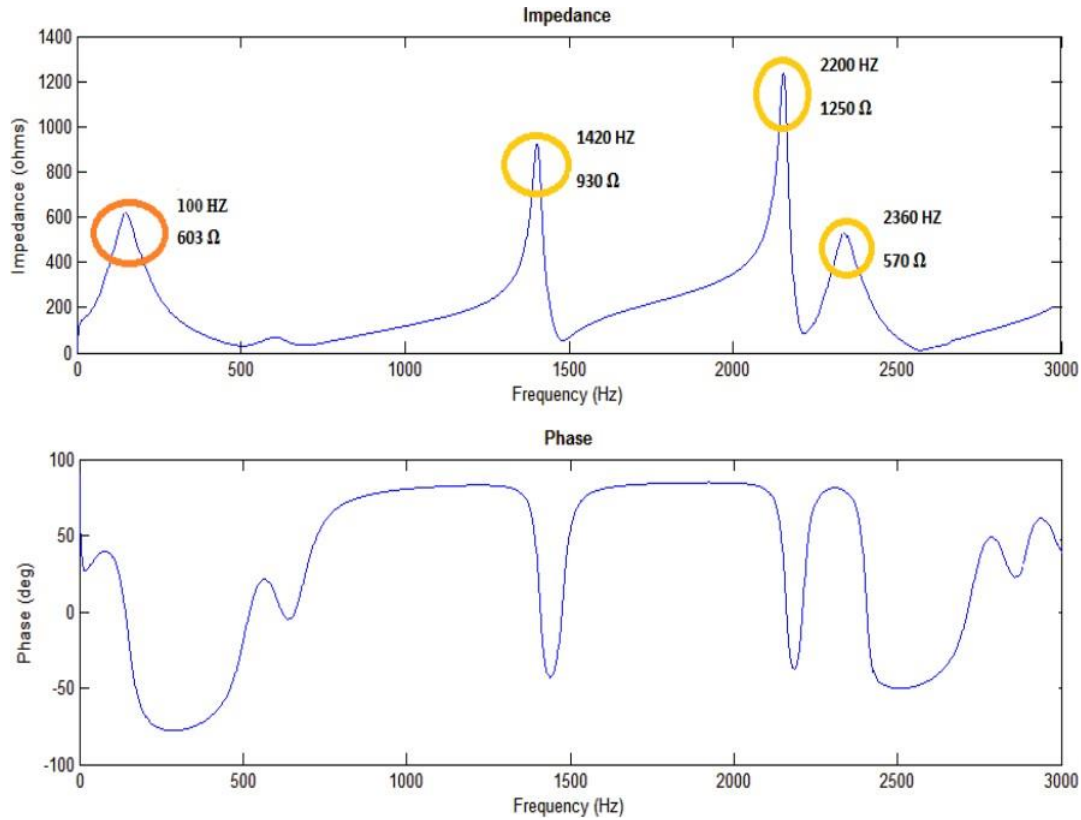

Fig. 8. Domain and angle of harmonic impedance in 150KV load bus

Frequency Scan

Harmonic currents crossing from system's impedance cause a harmonic voltage drop and consequently create harmonic voltages at two ends of load. Amount of voltage distortion depends to current impedance. While the current harmonics created by load finally because voltage distortion, however, one should keep in mind that load has no role on voltage distortion. A same load in different locations of power system creates two different amounts of distortion.

Fig. 8 shows the changes of system's impedance with harmonic frequency in buses 150 and 15 KV of Argostoli. Frequency scan is done for minimum load in here. Changes of harmonic impedance in load bus of average voltage appeared via first resonance parallel to upstream system. There are several resonance peaks in figure 8. Impedance of high voltage side is less affected by load changes which it is because of a more powerful system. Load model A is used here which shows the best characteristics after testing every three load. Several resonance peaks can be seen in Fig. 9 that depend on cables of the lines. The lowest frequency peak is about 100 Hz which belongs to the first order resonance of total high voltage shunt capacity with series inductance of upstream system. In frequency gain, impedance of system is inductive and about 2/2.5 Hz. Harmonic impedance of system in a specific bus depends on configuration of performance and load level.

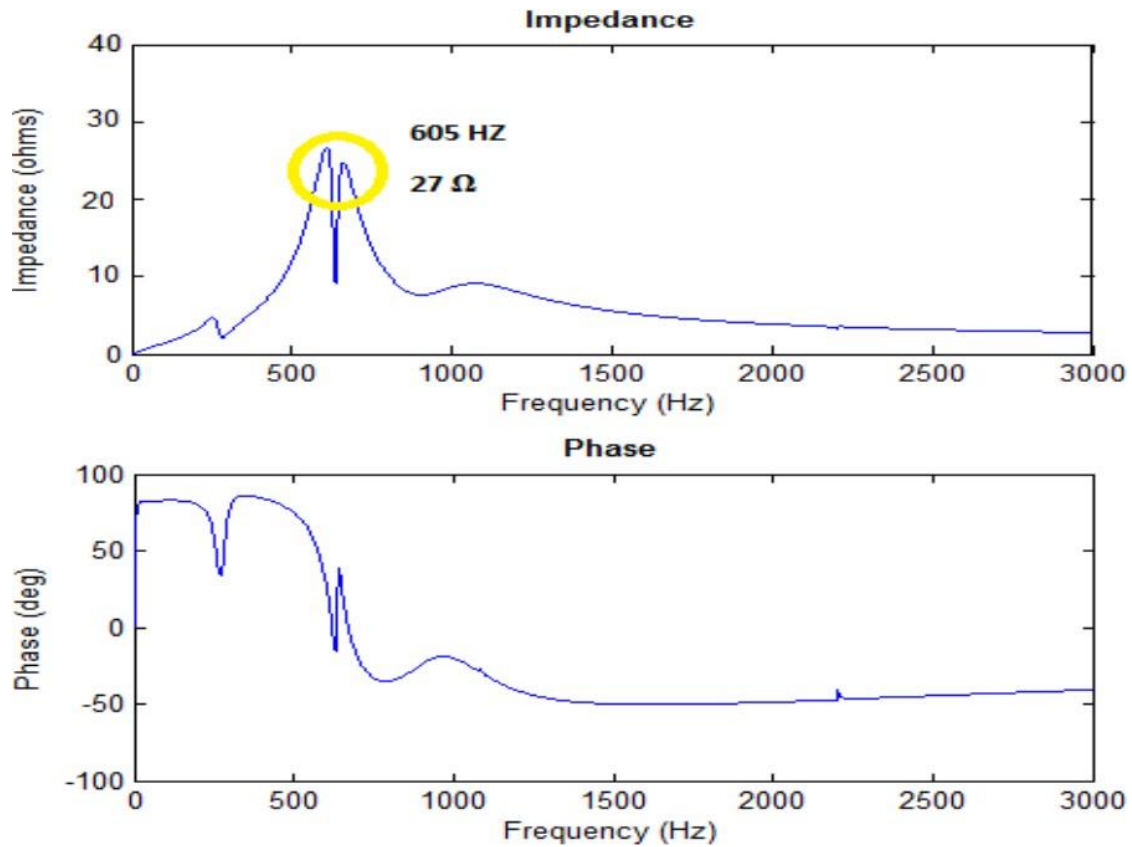

Fig. 9. Harmonic domain and impedance angle in wind farm PCC

Studied System for Iran

Accurate harmonic implementation and analysis in a system is a complicated task which includes developed models for all system's components including consumer's load. All components of system should be simulated by element's harmonic model and possibility of creation of resonance should be determined. All data of KAROUN 4's hydro plant and MANJIL's wind farm are recorded accurately and with permission from authorities of the two units. Network parameters are according to transmission and distribution lines of Iran. Single linear schematic view of studied system is indicated at Fig. 10, where hydropower plant consists four power production unit with capacity of 4'250 Mega Volt Amp toward high voltage system that have 400 KV of voltage to connect to it. A wind farm consisting 20 wind turbine with DFIG generators with capacity of 20'680 KW are present; this wind farm going toward an average voltage system with 20 KV to connect to it. Main network is also 5000 MVA and 400 KV. There is a Dyn11 transformer and 20 MV Amp in each high and average voltage station. This system also consists hundreds of kilometers of air lines with a 600 KW capacity. There are only positive and negative sequence harmonics because transformers with Dyn11 connection and zero sequence harmonics are removed. However, zero sequence harmonics may be produced and appear at the output because of power system configuration. Standard code IEC61000-3-6 monitors confining harmonic distribution in high and average voltage system [35].

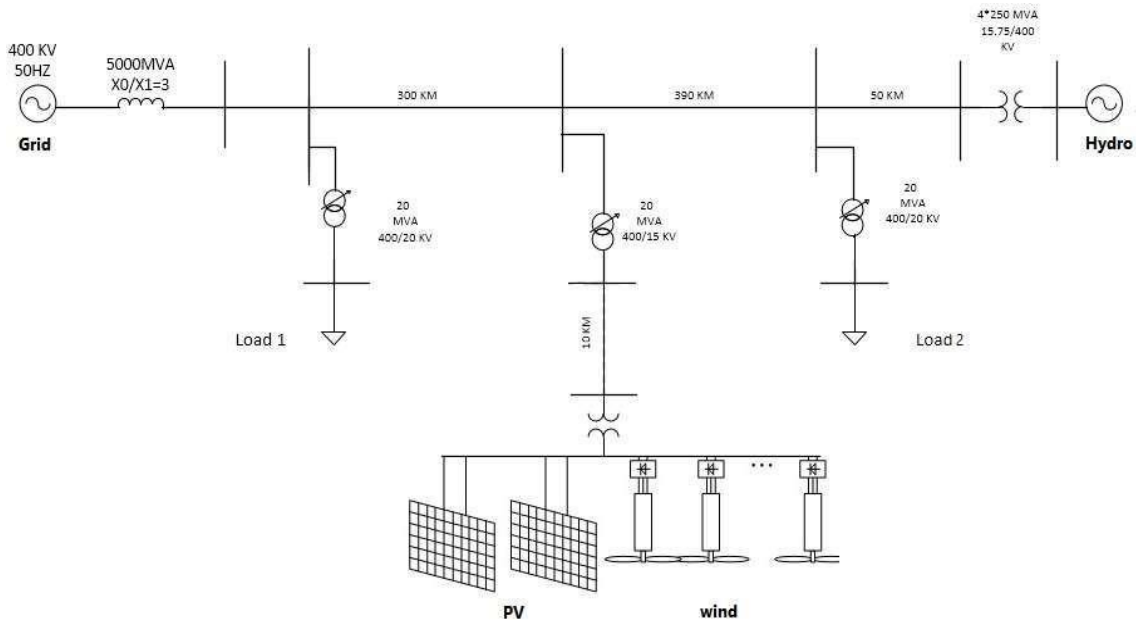

Fig. 10. Single linear diagram of studied power system

Hydro Plant (KAROUN 4)

KAROUN 4 storage dam and hydro plant is located in Chahar Mahal Va Bakhtiari province at 180 Km south west of Shahr-e Kord on KAROUN river. It is the biggest double-curvature concrete dam in Iran. The turbine used in this dam is a Francis type. Stream flow from Francis turbine is tuned by revolution of guide vanes via servo motor. KAROUN 4 dam's hydropower plant consists generator, turbine, excitation circuit, and transformers. An important issue in structure of high power generators is the heat that is created as a result of generators losses. There are two ways for increasing nominal power of generators; one is to decrease the losses and the other is to cool the generator down by extracting the heat generates the losses. Proper selection of winding and induction can minimize generators losses. Synchronous generator usually receives its excitation current from a permanent device which is installed on generators axel. As expressed, this power plant has a capacity of 1000 MVA. Stations of this power plant are connected to global network via a high voltage transmission system. Power plant's parameters and transformers characteristics are shown in Tables 3 and 4, respectively.

Table 3. Hydro plant parameters

(a) Turbine							
Parameter	K_p	K_i	K_d	T_d	K_a	T_a	T_w
Value	1.15	0.1	0	0.1	3.32	0.07	2.7
(b) Excitation circuit							
Parameter	T_b	K_a	T_a	T_e	K_f	T_f	K_e
Value	0	275	0.07	1	0.01	0.95	0
(c) Generator							
Parameter	R_s	X_d	X_q	X'_d	X''_q	R_{kd}	
Value	0.08	0.933	0.157	0.69	0.17	0.15	

Table 4. Characteristics of transformers in hydro plant

Main transformers Characteristics	
Number	13 devices
Type	Single phase
Nominal Power	100 MVA (single Phase)
Initial Nominal Power	15.75 KW
Secondary Nominal Power	710 KW
Cooling System	OFWF

Studied Wind Farm (MANJIL)

MANJIL's wind power plant is located in MANJIL Township, GEELAN province. This power plant converts wind's kinetic energy to electricity. Generators of turbines used in this power plant are double-fed induction generators (DFIG). Double-fed induction generators (DFIG) are selected between all power producing systems because of their low costs and operation in different wind conditions. One advantage of these generators is active and reactive power control capability. Modern wind turbines usually are equipped to power electronic convertors. Presence of these power convertors specifies percentage of harmonic amount in wind turbines. Both motor state and generator state are possible by feeding power electronic convertor which feeds rotors circuit by sliding rings and sweepers [36]. In case that rotor is fed with variable voltage by static power convertor it provides a constant voltage and frequency in stator. Therefore, high frequency time harmonics will exist in double-fed induction generator because of convertors presence and their switching strategy. These harmonics lead to high frequency harmonic losses [37]. Usually methods like pulse width modulation (PWM) and spatial vector modulation (SVM) are applied for controlling inverters. Rotors of high power inductive generators are fed by thyristor convertors. Six-pulse switching strategy is used in thyristor, usually. Using this method simplifies control system but its most important weakness is having all of $6k+1$ harmonics. Total harmonic distortion (THD) of produced voltage in this method is about 30 percent. Consequently, rotors current would be harmonic if rotor's feed voltage becomes harmonic. Presence of rotor's harmonic cause's creation of harmonics in stator's terminals besides creating torque oscillation. Harmonic problems caused by installation of these wind farms creates some concerns since wind power plants may inject harmonic pollutions into the systems. Harmonics in wind turbines are divided in two groups:

- a. Characteristic harmonics: depends on network frequency, rotor frequency, and switching frequency of power electronic convertors.
- b. Non-characteristic harmonics: are components which depend on working location of wind turbine.

Recognizing harmonic behavior of wind farms is basis for studying effect of these farms on network harmonic distortion. Therefore, evaluating wind farm harmonic spectrum and analysis of working location of wind turbines on harmonic distortion are of important issues in studying wind farms and hydropower plants.

Fast Fourier Transform (FFT)

FFT method is used for obtaining system harmonic components. First we measure current in hydro power plant bus. By simulating this section, according to Fig. 11 and

regarding results of system's Fourier transform we understood that THD in the concerned buses is less than 0.5 percent, according to Table 5, which this value is in normal range. If THD becomes more than 5 percent, it would be in critical state and solutions like filtering should be used for reducing system harmonics.

In second section, measurement of bus is performed in wind farm. This wind farm is connected to low voltage part of the system. As can be seen in Table 5 and Fig. 12, THD is 3.02 percent. One can see that this amount of distortion is result of wind farm's connection to system, but despite this amount of distortion, it does not cross critical range and this power system is launched without any further concern. Most of voltage and current distortion problems are seen in low voltage buses. Also most load changes in low voltages is seen with increase in harmonic distortion. However, loads react less to harmonic distortions and have lower changes in high voltage buses.

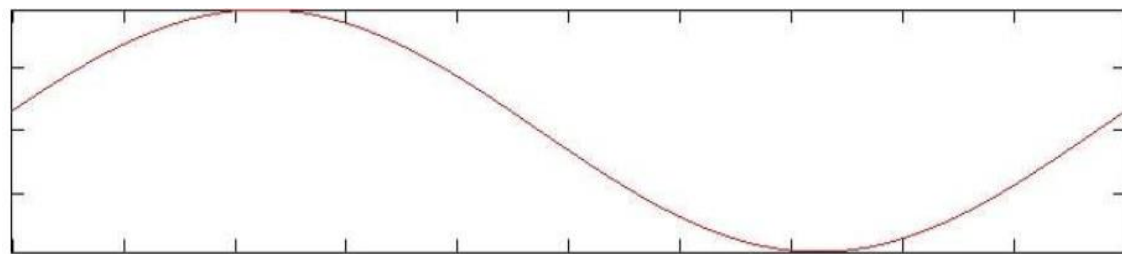

a. Output Current

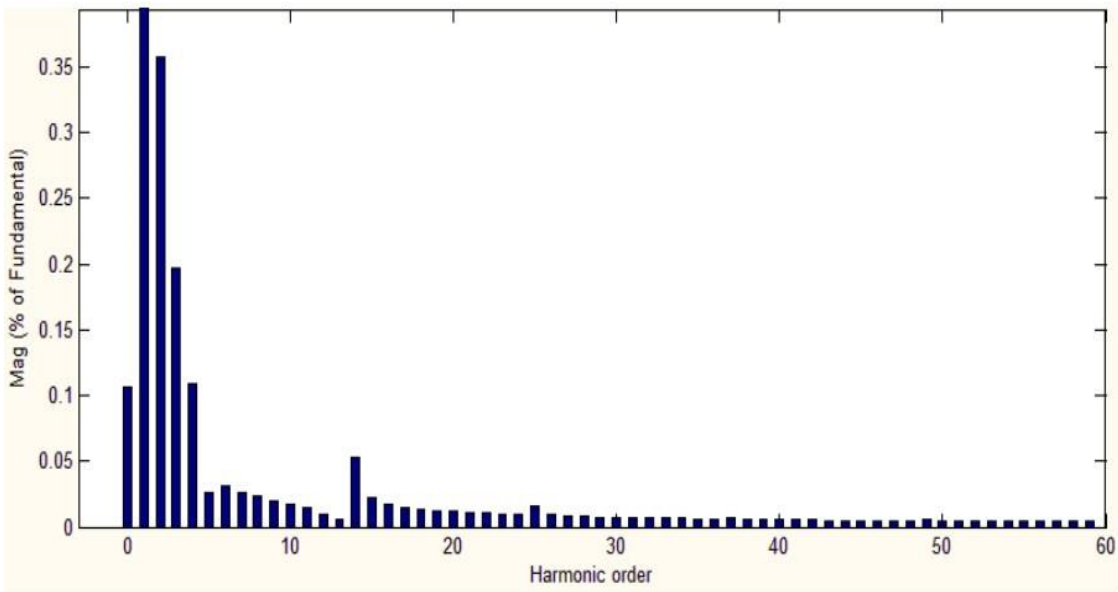

b. Total Harmonic distortion

Fig. 11. Output current and harmonic distortion of hydro turbine output

Table 5. Harmonic parameters in Buses in presence of wind farm and hydro plant

Bus Offer	Wind Farm's Bus		Water Turbine's Bus	
	Current Component	Voltage Component	Voltage Component	Voltage Component

1	1	1	1	1
3	98×10^{-2}	36×10^{-2}	19×10^{-2}	14×10^{-2}
5	60×10^{-2}	16×10^{-2}	11×10^{-2}	6×10^{-2}
7	42×10^{-2}	12×10^{-2}	7×10^{-2}	4×10^{-2}
9	33×10^{-2}	10×10^{-2}	6×10^{-2}	3×10^{-2}
11	28×10^{-2}	10×10^{-2}	5×10^{-2}	2×10^{-2}
13	23×10^{-2}	5×10^{-2}	4×10^{-2}	2×10^{-2}
15	20×10^{-2}	6×10^{-2}	3×10^{-2}	2×10^{-2}
17	18×10^{-2}	6×10^{-2}	3×10^{-2}	2×10^{-2}
19	16×10^{-2}	4×10^{-2}	3×10^{-2}	1×10^{-2}
21	13×10^{-2}	4×10^{-2}	3×10^{-2}	1×10^{-2}
Total harmonic Distortion	3.02%	2.78%	0.48%	0.35%

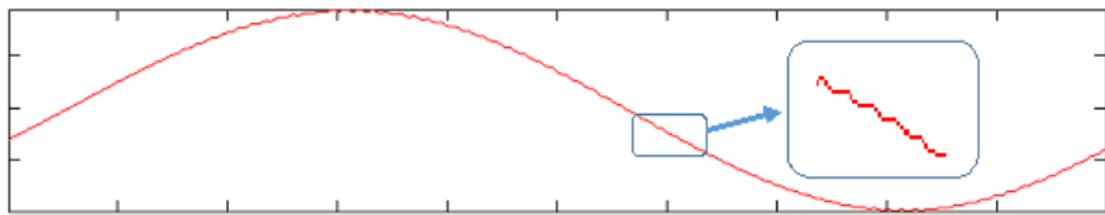

a. Output Current

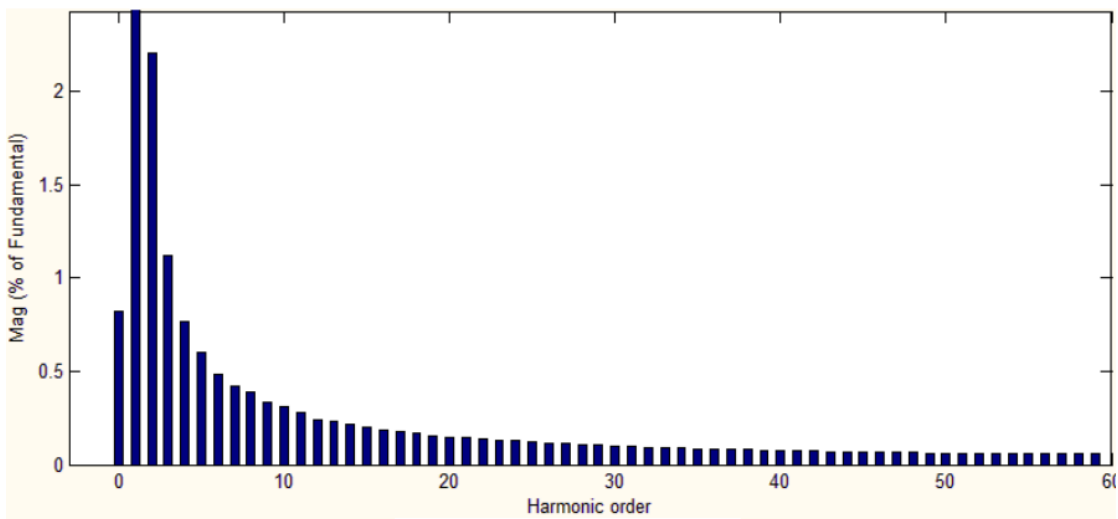

b. Total Harmonic distortion

Fig. 12. Output current and harmonic distortion of wind farm output

System Harmonic Impedance Characteristics (Frequency scan)

Frequency scan method is used for determining resonances created in system. For this purpose, we determine system impedance model via elements harmonic model and specify system's resonances by that. Fig. 13 indicates system impedance model by harmonic model of system components -which it is explained in harmonic models of system components in details. Harmonic currents which cross the system impedance cause a harmonic voltage drop and consequently lead to harmonic voltage at two ends of the load. Amount of distortion depends on current impedance. Although the current harmonic that are created by harmonic voltage consequently lead to voltage distortion,

one should keep this in mind that load has no control over voltage distortion. Where two similar load in different locations of a system create two different voltage distortion.

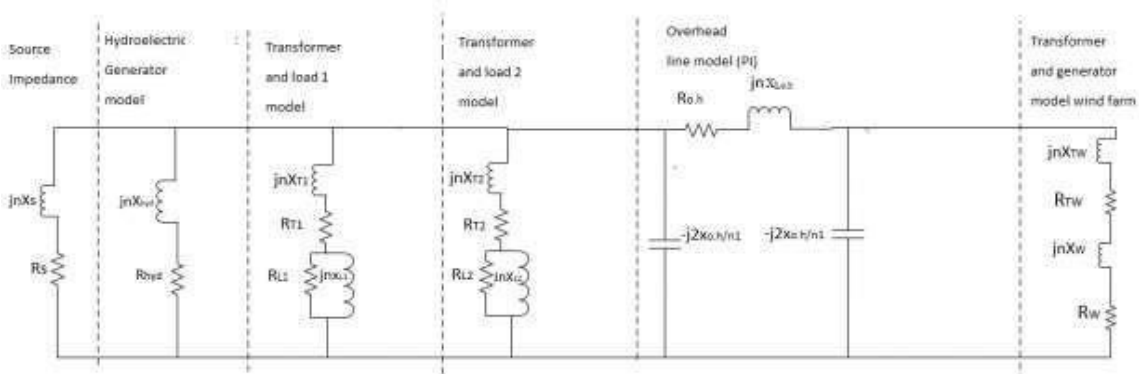

Fig. 13. Impedance circuit of studied model system

Table 6 shows impedance values of system. This values are obtained according to value of each element. Considerable increase in voltage and current values is result of a phenomena named resonance which is caused by capacitive and inductive properties. Natural frequency of circuit decreases with increase in capacitance. Reduction of main frequency and negligibility of its value and being close to low frequency harmonics affects main voltage.

Table 6. Values of System Impedance Circuit

Name of Facilities	Elements		Electrical Value (pu)
400 KW Air Lines	Roh, XL.oh, X.oh		0.025, 0.96, 0.58
Source of Network Poxer	RS, XS		10^{-3} , 0.0248×1.73
Transformer of load one or two	RT, XT		0.0149, 0.149
Wind Turbine Generator	RW, XW		0.03, 0.3
Hydro Turbine Generator	R_{hyd} , X_{hyd}		0.045, 0.54
Wind Turbine Transformers	R_{TW} , X_{TW}		0.056, 0.45
Load	Bus three load	RL1, XL1	8.51, 17.8
	Bus seven load	RL2, XL2	6.36, 13.15

Figs. 14 and 15 show impedance and probability of resonances created in the system; these resonances intensify resonance in case they interfere with harmonic orders that exist in system. Subsequently, harmonic domain significantly increases and this damages system facilities, including capacitors. Network short circuit's strength determents resonance. In case that internal resonance of a system is close to one of harmonics in the system, one can expect increase in the harmonic voltages caused by resonance intensification [38]. Resonance frequency in Hertz is obtainable by:

$$f_r = 50 \sqrt{\frac{S_K}{Q_C}}$$

Eqn. 10

where S_K is short circuit strength at point of common connection (PCC) and Q_C is compensatory capability. Short circuit strength at point of common connection is determined by transformers. One can place voltage distortion in permitted range by controlling system impedance, assuming current harmonics are in allowed range. System voltage harmonic distortion is obtainable by [39]:

$$U_n = Z_n I_n$$

Eqn. 11

where, Z_n and I_n are harmonic impedance at excitation point and harmonic current passing through system, respectively. As is shown in figure 10, impedance has high amounts at high voltage buses and this causes minimization of harmonic current at these buses. But in low voltage buses, like figure 15, the reverse is proven; harmonic current is significant because of low impedance percentage in these buses and this should be considered in system analysis. For instance, at figure 15, resonance is occurred at 600 Hz frequency which corresponds to thirteenth harmonic; or a resonance occurred at 250 Hz frequency which corresponds to fifth harmonic of system.

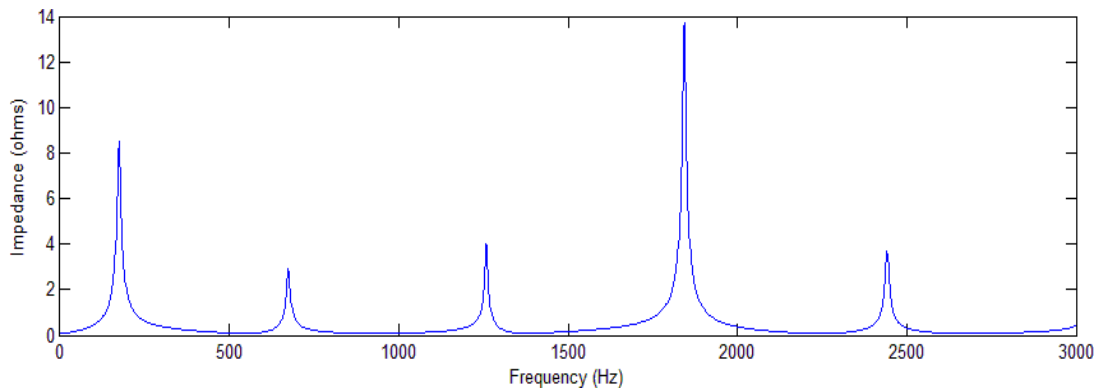

Fig. 14. Harmonic impedance domain in low voltage buses

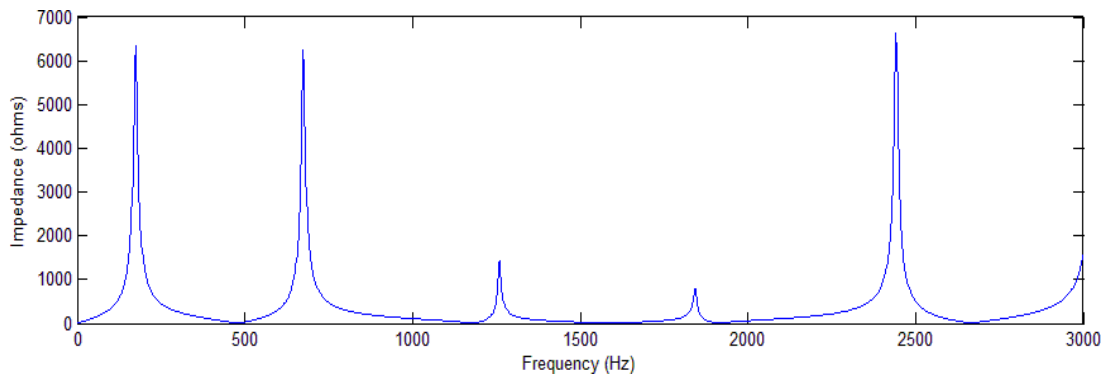

Fig. 15. Harmonic impedance domain in high voltage buses

CONCLUSION

Analysis of voltage and current harmonic distortion of a real system, consisting a hydro power plant and a wind farm, was presented in this paper. This complex is connected to a high voltage network. All voltage and current harmonic components are obtained via FFT analysis -as mentioned in table 5- and it shows that voltage and current harmonic distortion that are created by wind farm is significantly more than hydro power plants in a way that one can neglect distortion created by water turbine in power network (comparing to distortion of wind farms). Furthermore, system's resonances were determined by frequency scan. These resonances increase domain of harmonic in case of interference and occurrence in one frequency with the harmonics that are present in the system; this leads to damage toward system facility which we prevent this event by system harmonic analysis.

REFERENCES

- [1] R. Yan, T.K. Saha, N. Modi, N. Masood, M. Mosadeghy, "The combined effects of high penetration of wind and PV on power system frequency response", *Applied Energy*, Vol. 145, pp. 320–330, May 2015.
- [2] H. Karimi, G. Shahgholian, B. Fani, I. Sadeghkhan, M. Moazzami, "A protection strategy for inverter interfaced islanded microgrids with looped configuration", *Electrical Engineering*, Vol. 101, No. 3, pp. 1059-1073, Sep. 2019.
- [3] H. García, M. Madrigal, "Dynamic harmonic analysis of transformers", *IEEE Latin America Trans.*, Vol. 9, No. 7, pp. 1045-1050, Dec. 2011.
- [4] H.Y. Yua, R.C. Bansalb, Z.Y. Donga, "Fast computation of the maximum wind penetration based on frequency response in small isolated power systems", *Applied Energy*, Vol. 113, pp. 648–659, Jan. 2014.
- [5] J. Faiz, G. Shahgholian, "Modeling and simulation of a three-phase inverter with rectifier-type nonlinear loads", *Armenian Journal of Physics*, Vol.2, No.4, pp.307-316, 2009.
- [6] M. Zhang, C. Liu, Y. Han, G. Li, "Research on frequency oscillation of HVDC sending system in islanded mode of hydro power units", *Proceeding of the IEEE/POWERCON*, pp. 2394-2400, Chengdu, Oct. 2014.
- [7] A. Gaillard, P. Poure, S. Saadate, M. Machmoum "Variable speed DFIG wind energy system for power generation and harmonic current mitigation", *Renewable Energy*, Vol. 34, No. 6, pp. 1545-1553, June 2009.
- [8] S. Mikkili, A.K. Panda, "Instantaneous active and reactive power and current strategies for current harmonics cancellation in 3-ph 4-wire SHAF with both PI and Fuzzy controllers", *Energy and Power Engineering*, Vol. 3, pp. 285- 298, 2011.
- [9] P.W. Lehn, "Direct harmonic analysis of the voltage source converter", *IEEE Trans. on Power Delivery*, Vol.18, No.3, pp.1034-1042, July 2003.
- [10] J. Faiz, G. Shahgholian, M. Ehsan, "Stability analysis and simulation of a single-phase voltage source UPS inverter with two-stage cascade output filter", *European Transactions on Electrical Power*, Vol. 18, No. 1, pp. 29-49, Jan. 2008.
- [11] J. Wang, X. Du, G. Li, G. Yang, "Harmonic analysis of the interconnection of wind farm", *Electronics and Signal Processing*, Vol. 97, pp. 1031-1038, 2011.
- [12] G.K. Singh, "Power system harmonics research: a survey", *European Transactions on Electrical Power*, Vol. 19, No. 2, pp. 151-172, March 2009.

- [13] F.S. Reis, J.A.V. Ale, F.D. Adegas, R. Tonkoski, "Active shunt filter for harmonic mitigation in wind turbines generators", *Proceeding of the IEEE/PESC*, pp. 1-6, June 2006.
- [14] S. Agrawal, S.R. Mohanty, V. Agarwal, "Harmonics and inter harmonics estimation of DFIG based standalone wind power system by parametric techniques", *International Journal of Electrical Power and Energy Systems*, Vol. 67, pp. 52-65, May 2015.
- [15] K. Yang, M.H.J. Bollen, M. Wahlberg, "A comparison study of harmonic emission measurements in four wind parks", *Proceeding of the IEEE/PES*, pp. 1-7, San Diego, CA, July 2011.
- [16] G. Haghshenas, S.M.M. Mirtalaei, H. Mordmand, G. Shahgholian, "High step-up boost-flyback converter with soft switching for photovoltaic applications", *Journal of Circuits, Systems, and Computers*, Vol. 28, No. 1, pp. 1-16, Jan. 2019.
- [17] H. Ghaedi, G. Shahgholian, M. Hashemi, "Comparison of the effects of two flatness based control methods for STATCOM on improving stability in power systems including DFIG based wind farms", *Iranian Electric Industry Journal of Quality and Productivity*, Vol. 8, No. 15, p. 81-90, 2019.
- [18] A. Jafari, G. Shahgholian, M. Zamanifar, "Stability analysis of doubly-fed induction generator wind turbine systems using modal analysis", *Iranian Journal of Electrical and Computer Engineering*, Vol. 17, No. 3, pp. 173-189, Autumn 2019.
- [19] G. Shahgholian, N. Izadpanahi, "Improving the performance of wind turbine equipped with DFIG using STATCOM based on input-output feedback linearization controller", *Energy Equipment and Systems*, Vol. 4, No. 1, pp. 65-79, June 2016.
- [20] G. Shahgholian, K. Khani, M. Moazzami, "The Impact of DFIG based wind turbines in power system load frequency control with hydro turbine", *Dam and Hedroelectric Powerplant*, Vol. 1, No. 3, pp. 38-51, Winter 2015.
- [21] A.B. Attya, T. Hartkopf, "Penetration impact of wind farms equipped with frequency variations ride through algorithm on power system frequency response", *International Journal of Electrical Power and Energy Systems*, Vol. 40, No. 1, pp. 94-103, Sep. 2012.
- [22] J. Arrillaga, B.C. Smith, N.R. Watson, A.R. Wood, *Power system harmonic analysis*. New York, Wiley, 1998.
- [23] H. Novanda, P. Regulski, V. Stanojevic, V. Terzija, "Assessment of frequency and harmonic distortions during wind farm rejection test", *IEEE Trans. on Sustainable Energy*, Vol. 4, No. 3, pp. 698-705, July 2013.
- [24] L. Hirth, "The benefits of flexibility: The value of wind energy with hydropower", *Applied Energy*, Vol. 181, pp. 210-223, Nov. 2016.
- [25] P. K. Ray, B. Subudhi, "Neuro-evolutionary approaches to power system harmonics estimation", *International Journal of Electrical Power and Energy Systems*, Vol. 64, pp. 212-220, Jan. 2015.
- [26] T. Yang, H. Pen, D. Wang, Z. Wang, "Harmonic analysis in integrated energy system based on compressed sensing", *Applied Energy*, Vol. 165, pp. 583-591, March 2016.
- [27] P. Balciunas, N. Zdankus, "Harmonization of hydropower plant with the environment", *Renewable and Sustainable Energy Reviews*, Vol. 11, No. 6, pp. 1260-1274, August 2007.
- [28] A. Sarkar, S. R. Choudhury, S. Sengupta, "A self-synchronized ADALINE network for on-line tracking of power system harmonics", *Measurement*, Vol. 44, No. 4, pp. 784-790, May 2011.
- [29] F. Ghassemi, K.L. Koo, "Equivalent network for wind farm harmonic assessments", *IEEE Trans. on Power Delivery*, Vol. 25, No. 3, pp. 1808-1815, July 2010.
- [30] L. Sainz, J.J. Mesas, R. Teodorescu, "Deterministic and stochastic study of wind farm harmonic currents", *IEEE Trans. on Energy Conversion*, Vol. 25, No. 4, pp. 1071-1080, Dec. 2010.
- [31] S. Tentzerakis, N. Paraskevopoulou, S. Papathanassiou, P. Papadopoulos, "Measurement of wind farm harmonic emissions", *Proceeding of the IEEE/PES*, pp. 1769-1775, June 2008.
- [32] J. Faiz, G. Shahgholian, "Modelling and simulation of a three-phase inverter with rectifier-type nonlinear loads", *Armenian Journal of Physics*, Vol. 2, No. 4, pp. 307-316, 2009.

- [33] M. Bradt, B. Badrzadeh, E. Camm, D. Mueller, J. Schoene, T. Siebert, T. Smith, M. Starke, R. Walling, "Harmonics and resonance issues in wind power plants", Proceeding of the IEEE/PES, pp. 1-8, San Diego, CA , July 2011.
- [34] S.A. Papathanassiou, M.P. Papadopoulos, "Harmonic analysis in a power system with wind generation", IEEE Trans. on Power Delivery, Vol. 21, No. 4, pp. 2006–2016, Oct. 2006.
- [35] B. Badrzad, M. Gupta, N. Singh, A. Petersson, "Power system harmonic analysis in wind power plants- Part I: Study methodology and techniques", Proceeding of the IEEE/IAS, pp. 1-8, Las Vegas, NV, Oct. 2012.
- [36] S. Liang, Q. Hu, W.J. Lee, "A survey of harmonic emissions of a commercially operated wind farm", IEEE Trans. on Industry Applications, Vol. 48, No. 3, pp. 1115-1123, May/June 2012.
- [37] S.T. Tentzerakis, S.A. Papathanassiou, "An investigation of the harmonic emissions of wind turbines", IEEE Trans. on Energy Conversion, Vol. 22, No. 1, pp. 50-158, March 2007.
- [38] L. Fan, S. Yuvarajan, R. Kavasseri, "Harmonic analysis of a DFIG for a wind energy conversion system", IEEE Trans. on Energy Conversion, Vol. 25, No. 1, pp. 181-190, Mar. 2010.
- [39] T.M.H. Nicky, K. Tan, S. Islam, "Mitigation of harmonics in wind turbine driven variable speed permanent magnet synchronous generators", Proceeding of the IEEE/IPEC, Vol. 2, pp. 1159-1164, Singapore, Nov./Dec. 2005.